

Thyristor/Thyristor, 105 A (ADD-A-PAK™ Generation 5 Power Modules)



ADD-A-PAK™

PRODUCT SUMMARY

$I_{T(AV)}$	105 A
-------------	-------

MECHANICAL DESCRIPTION

The Generation 5 of ADD-A-PAK™ module combines the excellent thermal performance obtained by the usage of direct bonded copper substrate with superior mechanical ruggedness, thanks to the insertion of a solid copper baseplate at the bottom side of the device. The Cu baseplate allows an easier mounting on the majority of heatsink with increased tolerance of surface roughness and improved thermal spread. The Generation 5 of AAP modules is manufactured without hard mold, eliminating in this way any possible direct stress on the leads.

The electrical terminals are secured against axial pull-out: they are fixed to the module housing via a click-stop feature already tested and proved as reliable on other Vishay HPP modules.

FEATURES

- High voltage
- Industrial standard package
- Thick Al metal die and double stick bonding
- Thick copper baseplate
- UL E78996 approved
- 3500 V_{RMS} isolating voltage
- Totally lead (Pb)-free
- Designed and qualified for industrial level

**RoHS
COMPLIANT**

BENEFITS

- Up to 1600 V
- Full compatible TO-240AA
- High surge capability
- Easy mounting on heatsink
- Al₂O₃ DBC insulator
- Heatsink grounded

ELECTRICAL DESCRIPTION

These modules are intended for general purpose high voltage applications such as high voltage regulated power supplies, lighting circuits, temperature and motor speed control circuits, UPS and battery charger.

MAJOR RATINGS AND CHARACTERISTICS

SYMBOL	CHARACTERISTICS	VALUES	UNITS
$I_{T(AV)}$	85 °C	105	A
$I_{T(RMS)}$		165	
I_{TSM}	50 Hz	1785	
	60 Hz	1870	
I^2t	50 Hz	15.91	kA ² s
	60 Hz	14.52	
$I^2\sqrt{t}$		159.1	kA ² √s
V_{RRM}	Range	400 to 1600	V
T_{Stg}		- 40 to 125	°C
T_J		- 40 to 130	

ELECTRICAL SPECIFICATIONS

VOLTAGE RATINGS					
TYPE NUMBER	VOLTAGE CODE	V _{RRM} , MAXIMUM REPETITIVE PEAK REVERSE VOLTAGE V	V _{RSM} , MAXIMUM NON-REPETITIVE PEAK REVERSE VOLTAGE V	V _{DRM} , MAXIMUM REPETITIVE PEAK OFF-STATE VOLTAGE, GATE OPEN CIRCUIT V	I _{RRM} , I _{IDRM} AT 130 °C mA
VSKU/V105	04	400	500	400	20
	08	800	900	800	
	12	1200	1300	1200	
	16	1600	1700	1600	

ON-STATE CONDUCTION						
PARAMETER	SYMBOL	TEST CONDITIONS		VALUES	UNITS	
Maximum average on-state current	I _{T(AV)}	180° conduction, half sine wave, T _C = 85 °C		105	A	
Maximum continuous RMS on-state current	I _{T(RMS)}	DC		165		
		T _C		77	°C	
Maximum peak, one-cycle non-repetitive on-state current	I _{TSM}	t = 10 ms	No voltage reapplied	Sinusoidal half wave, initial T _J = T _J maximum	1785	A
		t = 8.3 ms			1870	
		t = 10 ms	100 % V _{RRM} reapplied		1500	
		t = 8.3 ms			1570	
		t = 10 ms	T _J = 25 °C no voltage reapplied		2000	
		t = 8.3 ms			2100	
Maximum I ² t for fusing	I ² t	t = 10 ms	No voltage reapplied	Initial T _J = T _J maximum	15.91	kA ² s
		t = 8.3 ms			14.52	
		t = 10 ms	100 % V _{RRM} reapplied		11.25	
		t = 8.3 ms			10.27	
		t = 10 ms	T _J = 25 °C no voltage reapplied		20.00	
		t = 8.3 ms			18.30	
Maximum I ² √t for fusing	I ² √t (1)	t = 0.1 to 10 ms, no voltage reapplied T _J = T _J maximum		159.1	kA ² √s	
Maximum value or threshold voltage	V _{T(TO)} (2)	Low level (3)	T _J = T _J maximum	0.80	V	
		High level (4)		0.85		
Maximum value of on-state slope resistance	r _t (2)	Low level (3)	T _J = T _J maximum	2.37	mΩ	
		High level (4)		2.25		
Maximum peak on-state or forward voltage	V _{TM}	I _{TM} = π × I _{T(AV)}	T _J = 25 °C	1.64	V	
	V _{FM}	I _{FM} = π × I _{F(AV)}				
Maximum non-repetitive rate of rise of turned on current	di/dt	T _J = 25 °C, from 0.67 V _{DRM} , I _{TM} = π × I _{T(AV)} , I _g = 500 mA, t _r < 0.5 μs, t _p > 6 μs		150	A/μs	
Maximum holding current	I _H	T _J = 25 °C, anode supply = 6 V, resistive load, gate open circuit		200	mA	
Maximum latching current	I _L	T _J = 25 °C, anode supply = 6 V, resistive load		400		

Notes

(1) I²t for time t_x = I²√t × √t_x

(2) Average power = V_{T(TO)} × I_{T(AV)} + r_t × (I_{T(RMS)})²

(3) 16.7 % × π × I_{AV} < I < π × I_{AV}

(4) I > π × I_{AV}



TRIGGERING					
PARAMETER	SYMBOL	TEST CONDITIONS		VALUES	UNITS
Maximum peak gate power	P_{GM}			12	W
Maximum average gate power	$P_{G(AV)}$			3	
Maximum peak gate current	I_{GM}			3	A
Maximum peak negative gate voltage	$-V_{GM}$			10	V
Maximum gate voltage required to trigger	V_{GT}	$T_J = -40\text{ °C}$	Anode supply = 6 V resistive load	4.0	
		$T_J = 25\text{ °C}$		2.5	
		$T_J = 125\text{ °C}$		1.7	
Maximum gate current required to trigger	I_{GT}	$T_J = -40\text{ °C}$	Anode supply = 6 V resistive load	270	mA
		$T_J = 25\text{ °C}$		150	
		$T_J = 125\text{ °C}$		80	
Maximum gate voltage that will not trigger	V_{GD}	$T_J = 125\text{ °C}$, rated V_{DRM} applied		0.25	V
Maximum gate current that will not trigger	I_{GD}			6	mA

BLOCKING					
PARAMETER	SYMBOL	TEST CONDITIONS		VALUES	UNITS
Maximum peak reverse and off-state leakage current at V_{RRM} , V_{DRM}	I_{RRM} , I_{DRM}	$T_J = 130\text{ °C}$, gate open circuit		20	mA
RMS insulation voltage	V_{INS}	50 Hz, circuit to base, all terminals shorted		2500 (1 min) 3500 (1 s)	V
Maximum critical rate of rise of off-state voltage	$dV/dt^{(1)}$	$T_J = 130\text{ °C}$, linear to $0.67 V_{DRM}$, gate open circuit		500	V/ μ s

Note

(1) Available with $dV/dt = 1000\text{ V}/\mu\text{s}$, to complete code add S90 i.e. VSKU105/16AS90

THERMAL AND MECHANICAL SPECIFICATIONS					
PARAMETER	SYMBOL	TEST CONDITIONS		VALUES	UNITS
Junction operating temperature range	T_J			- 40 to 130	°C
Storage temperature range	T_{Stg}			- 40 to 125	
Maximum internal thermal resistance, junction to case per module	R_{thJC}	DC operation		0.135	K/W
Typical thermal resistance, case to heatsink	R_{thCS}	Mounting surface flat, smooth and greased		0.1	
Mounting torque $\pm 10\%$		to heatsink	A mounting compound is recommended and the torque should be rechecked after a period of 3 hours to allow for the spread of the compound.	5	Nm
		busbar		3	
Approximate weight				110	g
				4	oz.
Case style		JEDEC		TO-240AA	

ΔR CONDUCTION PER JUNCTION											
DEVICES	SINE HALF WAVE CONDUCTION					RECTANGULAR WAVE CONDUCTION					UNITS
	180°	120°	90°	60°	30°	180°	120°	90°	60°	30°	
VSKU/V105	0.04	0.05	0.06	0.08	0.12	0.03	0.05	0.06	0.08	0.12	°C/W

Note

• Table shows the increment of thermal resistance R_{thJC} when devices operate at different conduction angles than DC

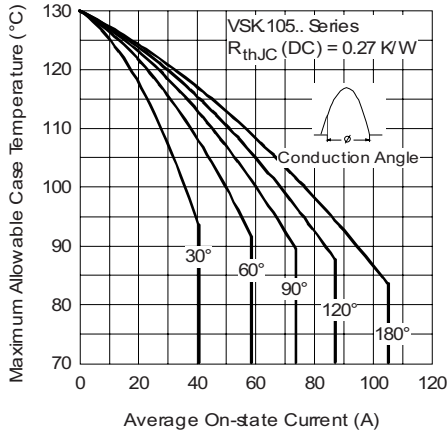

Fig. 1 - Current Ratings Characteristics

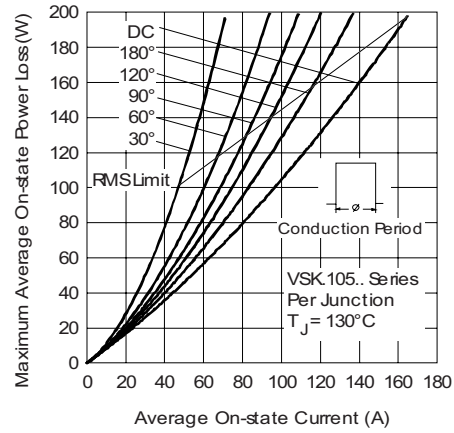

Fig. 4 - On-State Power Loss Characteristics

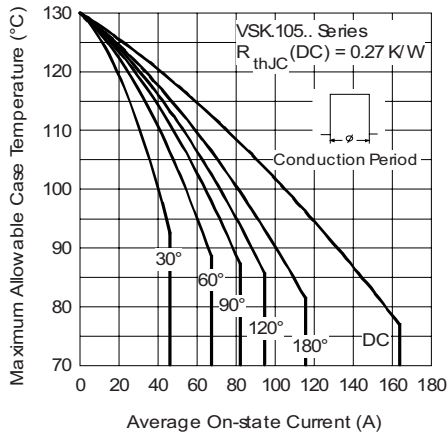

Fig. 2 - Current Ratings Characteristics

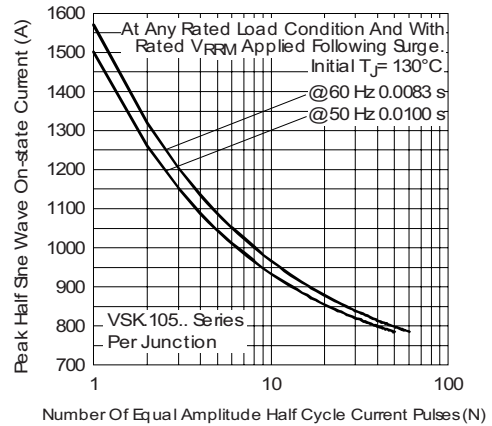

Fig. 5 - Maximum Non-Repetitive Surge Current

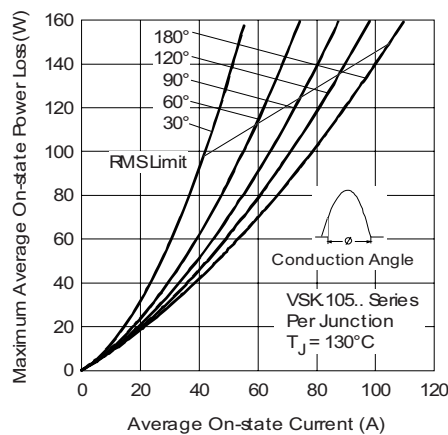

Fig. 3 - On-State Power Loss Characteristics

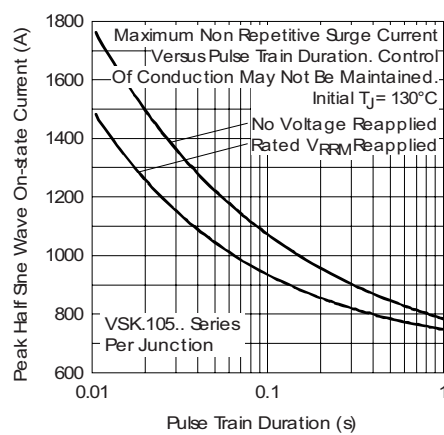

Fig. 6 - Maximum Non-Repetitive Surge Current

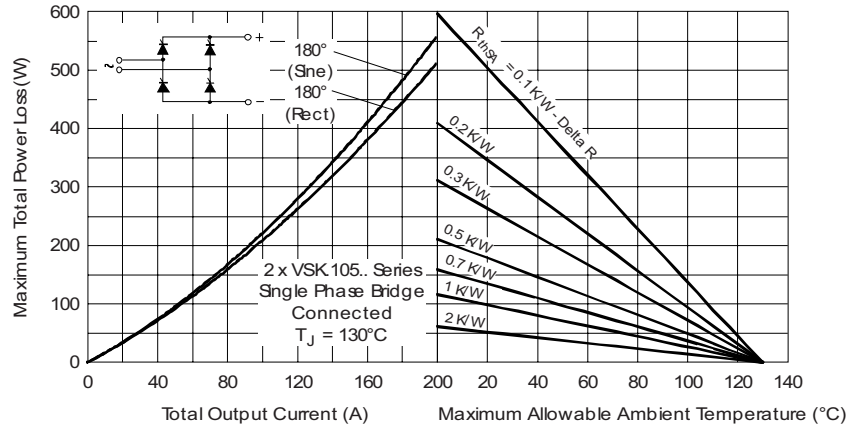

Fig. 7 - On-State Power Loss Characteristics (Single Phase Bridge VSKU + VSKV)

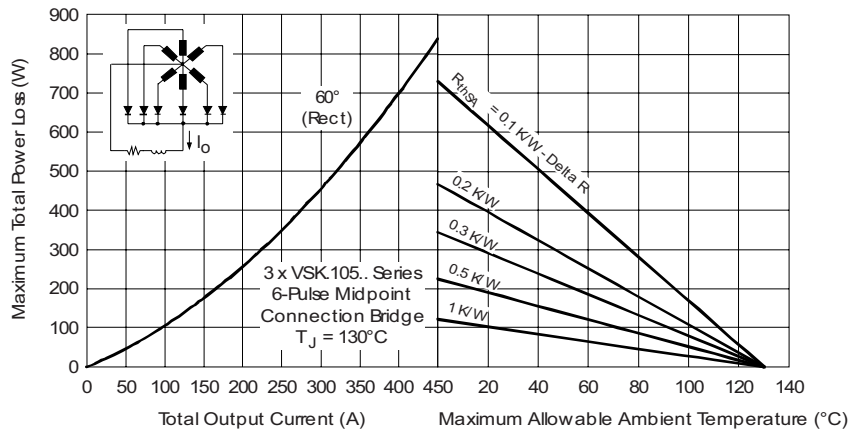

Fig. 8 - On-State Power Loss Characteristics

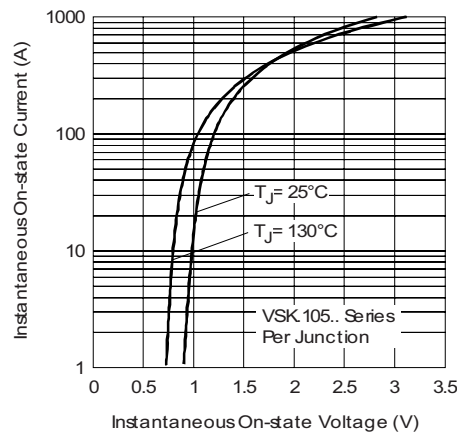

Fig. 9 - On-State Voltage Drop Characteristics

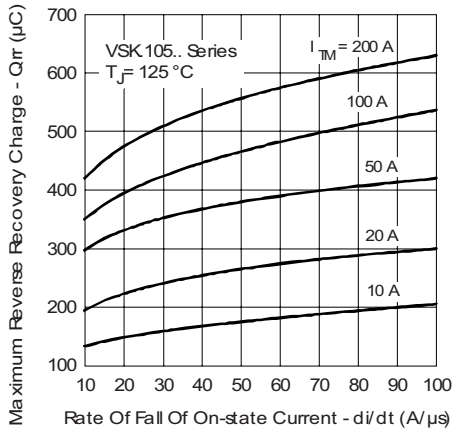

Fig. 10 - Current Ratings Characteristics

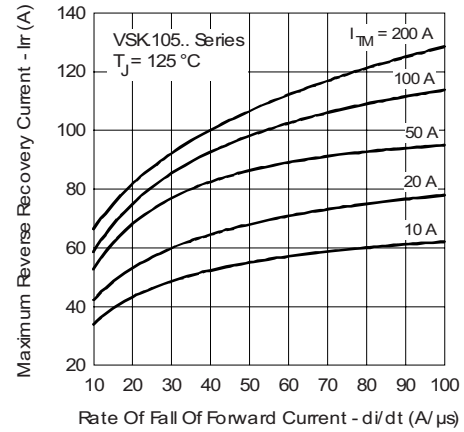

Fig. 11 - Current Ratings Characteristics

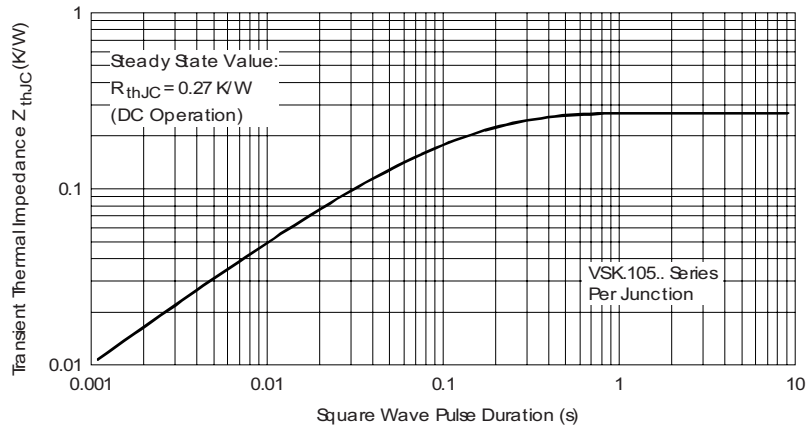

Fig. 12 - Thermal Impedance Z_{thJC} Characteristics

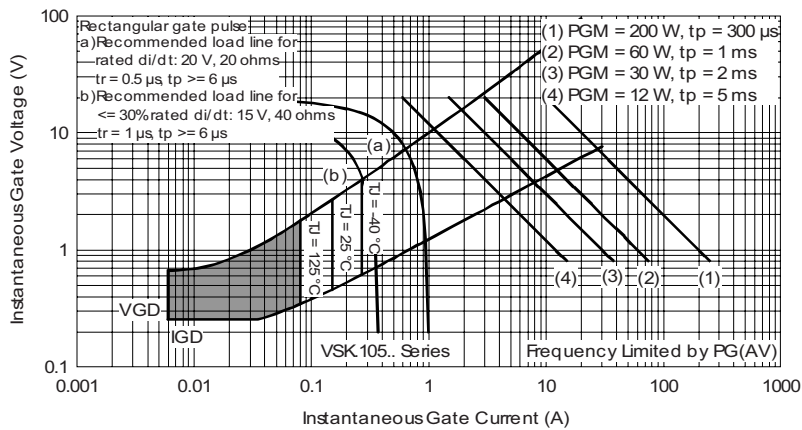
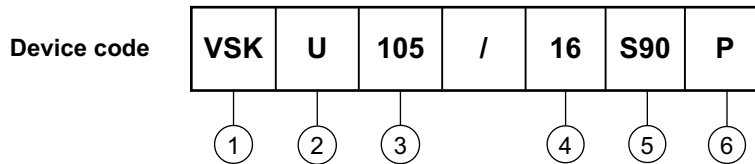

Fig. 13 - Gate Characteristics



ORDERING INFORMATION TABLE



- 1** - Module type
- 2** - Circuit configuration (see end of datasheet)
- 3** - Current code ⁽¹⁾
- 4** - Voltage code (see Voltage Ratings table)
- 5** - dV/dt code: S90 = dV/dt 1000 V/μs
No letter = dV/dt 500 V/μs
- 6** - P = Lead (Pb)-free

⁽¹⁾ Available with no auxiliary cathode

(for details see dimensions - link at the end of datasheet)

To specify change: 105 to 106

e.g.: VSKU106/16P etc.

Note

- To order the optional hardware go to www.vishay.com/doc?95172

CIRCUIT CONFIGURATION

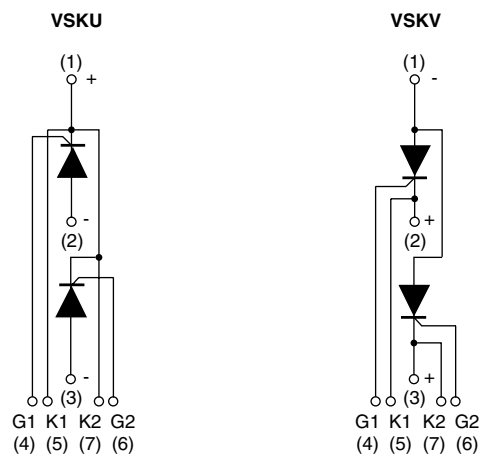

LINKS TO RELATED DOCUMENTS

Dimensions	http://www.vishay.com/doc?95087
------------	---



Disclaimer

All product specifications and data are subject to change without notice.

Vishay Intertechnology, Inc., its affiliates, agents, and employees, and all persons acting on its or their behalf (collectively, "Vishay"), disclaim any and all liability for any errors, inaccuracies or incompleteness contained herein or in any other disclosure relating to any product.

Vishay disclaims any and all liability arising out of the use or application of any product described herein or of any information provided herein to the maximum extent permitted by law. The product specifications do not expand or otherwise modify Vishay's terms and conditions of purchase, including but not limited to the warranty expressed therein, which apply to these products.

No license, express or implied, by estoppel or otherwise, to any intellectual property rights is granted by this document or by any conduct of Vishay.

The products shown herein are not designed for use in medical, life-saving, or life-sustaining applications unless otherwise expressly indicated. Customers using or selling Vishay products not expressly indicated for use in such applications do so entirely at their own risk and agree to fully indemnify Vishay for any damages arising or resulting from such use or sale. Please contact authorized Vishay personnel to obtain written terms and conditions regarding products designed for such applications.

Product names and markings noted herein may be trademarks of their respective owners.